

THANK YOU FOR VOTING TEXECOM

INSTALLATION MANUAL

Veritas 8

Veritas 8 Compact

Veritas R8

Security Control Panels

Issue 12



Texecom
www.texe.com

Contents

1. Quick Reference and Factory Settings.....	3	Programming Zone Types	①① - ①⑧21
Programming Guide	3	24 Hour Zone Types.....	22
Miscellaneous Options	4	Programming the Zone Type	①① - ①⑧22
Reference Table	4	Changing Part Set Zone Types ..	②① - ②③22
2. System Overview	5	Changing Zones to Entry/Exit	②①23
System Architecture.....	5	Changing Zones to Inhibited Entry	②②23
Control Panels	5	Changing Zones to Guard	②③23
<i>Veritas V8, V8Compact</i>	5	Programming the Date and Time	②⑤ - ②⑥23
<i>Veritas R8</i>	5	Programming the Date	②⑤23
Remote Keypad.....	5	Programming the Time	②⑥23
<i>Veritas R8 Remote Keypad</i>	5	Programming the Service Timers	②⑦ - ②⑨24
3. Installation	6	Programming Service Timer One	②⑦24
Installation Sequence	6	Programming Service Timer Two	②⑧24
Control Panel	6	Programming Service Timer Three	②⑨24
Mounting the Control Panel.....	6	Programming System Timers	③① - ③⑨24
Wiring the Control Panel.....	6	The Seven Event Basic Log	④① - ④⑦25
<i>Veritas 8 and R8 Control Panel PCB Layout</i>	7	Clearing the Seven Event Basic Log	④①25
<i>Veritas 8Compact Control Panel PCB Layout</i>	8	Displaying the Seven Event Basic Log	④① - ④⑦25
Connecting AC Mains.....	9	Programming the Suites	④⑧ - ⑤⑨25
Connecting Batteries	9	Programming the Zone Disable Suite	④⑧25
Installing Remote Keypads	9	Programming the Zone Soak Test Suite	④⑨25
Cable Distances.....	9	Programming the Part Set Suites	⑤① - ⑤②26
Keypad Addressing	9	Programming the Chime Suite	⑤⑤26
Configuring the Keypads.....	9	Programming the Double Knock Suite	⑤⑦26
Zone Connections.....	10	Programming the Manual Omit Suite	⑤⑧26
Magnetic Contacts and Panic Buttons.....	10	Programming Codes	⑥① - ⑥⑨26
Powered Detectors	11	Changing the Engineers Code	⑥①26
Global System Tamper	12	5. Specifications	27
Speaker Connections	12	Control Panel.....	27
Internal Siren(s)	12	Power supply.....	27
Wiring the External Sounder	13	Electrical	27
Popular SAB Wiring Diagrams	13	Physical	27
Commissioning (Initial Power Up)	14	Environmental.....	27
Servicing the System.....	15	Keypads.....	27
Trouble Shooting	15	Safety Notes	27
4. Programming the Control Panel	17	Warranty	27
Introduction.....	17	European Standards	28
The Programming Menu.....	17	EN 50131	28
The Miscellaneous Selections	①① - ①③17	6. Installation Records	29
Miscellaneous Selections Zero	①①17	Installation Details.....	29
Miscellaneous Selections One	①②18	Maintenance & Call-Out Record	29
Miscellaneous Selections Two	①③18	Notes	30
Miscellaneous Selections Three	①④19	7. Registered Installer Application Form	31
Number of Alarm Activations (Re-arms)	①⑤19		
Testing the Sounders, Strobe	①⑥19		
Walk Testing	①⑦ or ①⑧20		
Re-Loading the Factory Settings	①⑨20		
Programming the SW+ Output	②①20		
Configuring Remote Keypads	②②21		

1. Quick Reference and Factory Settings

Programming Guide

Programming Option	Option Code	Programming Procedure	Factory Setting
Miscellaneous Selections Zero	0 0	Select/De-select Option Number(s) (1) to (8) Press (PROG.)	
Miscellaneous Selections One	0 1	Select/De-select Option Number(s) (1) to (8) Press (PROG.)	
Miscellaneous Selections Two	0 2	Select/De-select Option Number(s) (1) to (8) Press (PROG.)	
Miscellaneous Selections Three	0 3	Select/De-select Option Number(s) (1) to (8) Press (PROG.)	
Number of Alarm Activations	0 4	Enter Number of Alarm Activations (?) (?) Press (PROG.)	03
Test Sounders, Strobe, SW+	0 5	Press (5) (4) (3) (2) (1) in Turn Press (RESET)	
Walk Test (Non-Latching)	0 6	Conduct Walk Test Press (RESET)	
Re-Load Factory Settings	0 7	Press (PROG.)	
Switched Positive Output	0 8	Select Function (1) to (8) Press (PROG.)	Set +Ve with Reset (6)
Configure Remote Keypads	0 9	View Display Press (PROG.)	
Zone 1 Zone Type	1 1	Select Zone Type (1) to (8) Press (PROG.)	Entry/Exit (6)
Zone 2 Zone Type	1 2	Select Zone Type (1) to (8) Press (PROG.)	Inhibited Entry (2)
Zone 3 Zone Type	1 3	Select Zone Type (1) to (8) Press (PROG.)	Guard (3)
Zone 4 Zone Type	1 4	Select Zone Type (1) to (8) Press (PROG.)	Guard (3)
Zone 5 Zone Type	1 5	Select Zone Type (1) to (8) Press (PROG.)	Guard (3)
Zone 6 Zone Type	1 6	Select Zone Type (1) to (8) Press (PROG.)	Guard (3)
Zone 7 Zone Type	1 7	Select Zone Type (1) to (8) Press (PROG.)	Guard (3)
Zone 8 Zone Type	1 8	Select Zone Type (1) to (8) Press (PROG.)	Guard (3)
Walk Test (Latching)	1 9	Conduct Walk Test Press (RESET)	
hChange into Entry/Exit Suite	2 1	Select Zone Number(s) (1) to (8) Press (PROG.)	Zone 2 Included
Change into Inhibited Entry Suite	2 2	Select Zone Number(s) (1) to (8) Press (PROG.)	No Zones Included
Change into Guard Suite	2 3	Select Zone Number(s) (1) to (8) Press (PROG.)	Zone 1 Included
Program Current Date	2 5	Enter Date DD/MM/YY Press (PROG.)	
Program Current Time	2 6	Enter Time HH:MM:SS Press (PROG.)	
Program Service Timer 1 Date	2 7	Enter Date DD/MM/YY Press (PROG.)	
Program Service Timer 2 Date	2 8	Enter Date DD/MM/YY Press (PROG.)	
Program Service Timer 3 Date	2 9	Enter Date DD/MM/YY Press (PROG.)	
Full Set Exit Time (sec)	3 1	Enter Exit Time (?) (?) Press (PROG.)	30 sec
Part Set Exit Time (sec)	3 2	Enter Exit Time (?) (?) Press (PROG.)	30 sec
Full Set Entry Time (sec)	3 3	Enter Entry Time (?) (?) Press (PROG.)	30 sec
Part Set Entry Time (sec)	3 4	Enter Entry Time (?) (?) Press (PROG.)	30 sec
Bell Cut-Off Time (min)	3 5	Enter Cut-Off Time (?) (?) Press (PROG.)	15 min
Error Tone Suspension Time (sec)	3 6	Enter Suspension Time (?) (?) Press (PROG.)	10 sec
Zone Soak Test Time (days)	3 9	Enter Soak Test Time (?) (?) Press (PROG.)	14 days
Clear Seven Event Basic Log	4 0	Press (PROG.)	
Basic Log Event 1 (most recent)	4 1	View Display (Press (MEM) for Extended Display) Press (RESET)	
Basic Log Event 2	4 2	View Display (Press (MEM) for Extended Display) Press (RESET)	
Basic Log Event 3	4 3	View Display (Press (MEM) for Extended Display) Press (RESET)	
Basic Log Event 4	4 4	View Display (Press (MEM) for Extended Display) Press (RESET)	
Basic Log Event 5	4 5	View Display (Press (MEM) for Extended Display) Press (RESET)	
Basic Log Event 6	4 6	View Display (Press (MEM) for Extended Display) Press (RESET)	
Basic Log Event 7 (least recent)	4 7	View Display (Press (MEM) for Extended Display) Press (RESET)	
Zone Disable Suite	4 8	Select Zone Number(s) (1) to (8) Press (PROG.)	No Zones Included
Zone Soak Test Suite	4 9	Select Zone Number(s) (1) to (8) Press (PROG.)	No Zones Included
Part Set Suite 1	5 1	Select Zone Number(s) (1) to (8) Press (PROG.)	Zones 5, 6, 7 Omitted
Part Set Suite 2	5 2	Select Zone Number(s) (1) to (8) Press (PROG.)	Zones 5, 6, 7 Omitted
Chime Suite	5 5	Select Zone Number(s) (1) to (8) Press (PROG.)	No Zones Included
Double Knock Suite	5 7	Select Zone Number(s) (1) to (8) Press (PROG.)	No Zones Included
Manual Omit Suite	5 8	Select Zone Number(s) (1) to (8) Press (PROG.)	Zone 1 Omitted
Program Your Own Code PIN	6 0	Enter New Code PIN (?) (?) (?) (?) Press (PROG.)	1234
Display Panel Type	7 0	View Display Press (RESET)	Z1, Z2 On

Miscellaneous Options

Option	Miscellaneous Selections Zero ①①	Factory Setting
1	Cancel Strobe with Bell	Off
2	Keypad PA (pressing ③ and ⑨ together causes PA alarm)	On
3	Single Button Setting	On
4	Silent Part Set Confirmation Tone	Off
5	EN 50131-1 Requirements	Off
6	Time Limit Engineer Access	Off
7	Reset Button Cancels Setting	On
8	Automatically Omit a Mains Fail Condition (Auto-Omit AC Off)	Off

Option	Miscellaneous Selections One ①①	Factory Setting
1	Internal Sounders Only on Unset Tamper Alarm	On
2	Internal Sounders Only on Part Set Zone Alarm	On
3	Internal Sounders Only on Part Set Tamper Alarm	On
4	Silent Part Set (no exit tone on part set)	Off
5	High Level Chime (chime at full volume)	Off
6	Invert Bell Output (negative removed instead of negative applied, useful for SCBs)	Off
7	Final Door Set (system sets 3 seconds after final door closure)	Off
8	Unlock Engineer Code (re-loading factory settings restores default Engineer code)	On

Option	Miscellaneous Selections Two ①②	Factory Setting
1	Engineer Reset on Any Alarm (see page 18)	Off
2	Engineer Reset on Tamper Alarm (see page 18)	Off
3	Disable User Ability to Omit Tamper	Off
4	Code PIN Tamper (tamper alarm after 16 invalid key presses when unset)	Off
5	Random Number Remote Reset (RNRR, see page 18)	Off
6	Push To Set (see page 19)	Off
7	Strobe Flash on Full Set (see page 18)	On
8	Invert Switched Positive Output (off = negative removed, on = negative applied)	Off

Option	Miscellaneous Selections Three ①③	Factory Setting
1	Mains Frequency (off = 50Hz, on = 60Hz)	Off
2	Reserved for Future Use	Off
3	Reserved for Future Use	Off
4	Reserved for Future Use	Off
5	Reserved for Future Use	Off
6	Reserved for Future Use	Off
7	Reserved for Future Use	Off
8	Reserved for Future Use	Off

Reference Table

Number	Test Outputs ①⑤	SW= Function ①⑧	Zone Types ①②	Extended Display
0	All Off			
1	Bell	Set +Ve	Push To Set	Bell & Global Tamper
2	Strobe	Alarm +Ve & Reset	Inhibit Entry	Power
3	Sounder Lo	Reset	Guard	Lid Tamper (inc. RKP)
4	Sounder Hi	Tamper	Fire	
5	SW+	Mains Fail	Tamper	RKP Off-Line
6	Engineer Hold Off	Set +Ve & Reset	Entry/Exit	Code PIN Tamper
7		Walk Test	PA	Keypad PA
8		Entry/Exit	Keyswitch	

2. System Overview

System Architecture

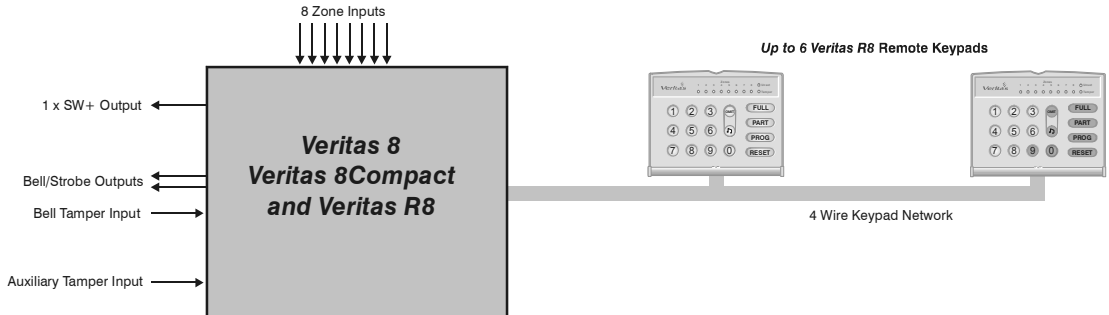

Control Panels

Veritas 8, V8Compact

- 8 fully programmable Single Pole zones + Global Tamper
- 1 User Code
- Built-in Keypad and Display
- Up to 6 LED keypads
- 4-wire data network (standard 7/0.2 alarm cable)
- 2 Part Suites plus Full Set

Veritas R8

- 8 fully programmable Single Pole zones + Global Tamper
- 1 User Code
- Blank end station and LED Remote Keypad
- Up to 6 LED keypads
- 4-wire data network (standard 7/0.2 alarm cable)
- 2 Part Suites plus Full Set

Remote Keypad

Veritas R8 Remote Keypad

- LED keypad (8 zone indicators, tamper, power and unset)
- Tactile Rubber keypad buttons
- Keypad cover
- Keypad PA (3 & 9)
- 4-wire connection to remote keypad network
- Built in Piezo sounder

3. Installation

Installation Sequence

Before attempting to install the alarm system, read this section. Once you have an overall understanding of the installation sequence, carefully work through each step.

1. Design the Layout

Make a rough sketch of the premises to get an idea of where the alarm detection devices, keypads etc. are to be located.

2. Mounting the Panel

The control panel should be mounted in a dry area close to an unswitched AC power source.



You must complete all wiring before connecting the battery or applying AC mains to the control panel.

3. Installing the Keypads

Mount and connect the keypads to the control panel (see page 9 for wiring details).

4. Installing the Alarm Detection Devices

Install the detection devices, PIR's, Contacts, PA Buttons etc. and connect them to the control panel (see page 10).

5. Install the External Sounder

Install the external sounder and connect to the control panel (see page 13).

6. Other Wiring

Complete all other wiring i.e. speakers etc. (see pages 12 for wiring details).

7. Applying Power to the Control Panel

Once steps 1 to 6 are completed, power can be applied to the control panel.



If you need to load the factory default settings (see page 14).

Power should always be connected in the following order:

- Connect the red battery lead to the positive terminal of the battery and then connect the black battery lead to the negative terminal.
- Connect the AC mains.

8. Programming the Control Panel

Please refer to section 4 for instruction on programming the control panel.

9. Testing the System

Test the system thoroughly to ensure that all features and functions operate as required (see page 19).

Control Panel

Mounting the Control Panel

Mount the control panel on a flat, plumb wall using at least three appropriate screws. The rear casing has been designed with a central key-hole slot so that mounting is possible without removing the Printed Circuit Board (PCB). The angled slot in the lower corner has been provided to allow the panel to be levelled easily. If the PCB has to be removed, carefully pull back the two front PCB securing clips, lift the front of the PCB and slide it downward. To replace the PCB simply reverse the above procedure.



It is essential to ensure that none of the fixing slots or cable entries are accessible after fixing.

Mains cabling must be secured (e.g. with a cable tie) to one of the anchor points provided.

Wiring the Control Panel

WARNING: ELECTRICITY CAN KILL
BEFORE connecting the control panel
ALWAYS disconnect the supply at the
consumer unit. If in ANY doubt consult
a qualified electrician.



IMPORTANT SAFETY INFORMATION.
HAZARDOUS VOLTAGES INSIDE, NO USER
SERVICEABLE PARTS, NO USER ACCESS.



ONLY connect the mains supply to the mains terminal block, NEVER connect the mains supply directly to the PCB.

ALWAYS refer to National Wiring Regulations when conducting installation.

An appropriate and readily accessible disconnection device (e.g. an unswitched fused spur) MUST be provided as part of the installation.

The disconnection device must NOT be fitted in a flexible cord.

Where identification of the neutral in the mains supply is NOT possible a two-pole disconnection device MUST be used.

The building mains supply MUST incorporate appropriate short-circuit backup protection (e.g. a fuse or circuit breaker) of High Breaking Capacity (HBC, at least 1500A).

Use mains cable of adequate carrying capacity for the rated current (i.e. at least 0.75mm²).

Veritas 8 and R8 Control Panel PCB Layout

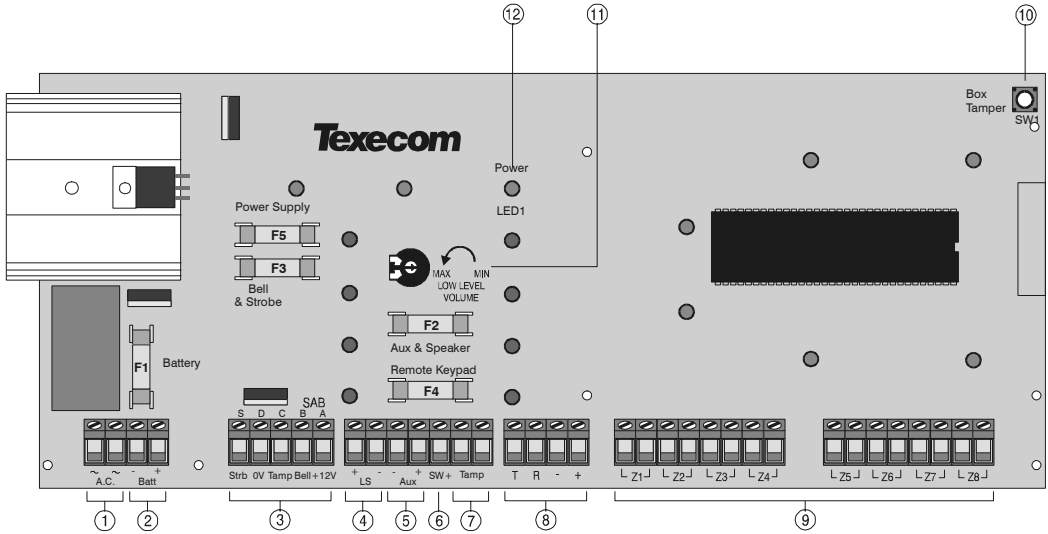

The PCB shown is the Veritas 8 the Veritas R8 PCB may differ slightly

1: AC Input

Connected to the 16.5V transformer.

⚠ DO NOT CONNECT THE MAINS SUPPLY TO THE AC INPUT TERMINALS ON THE PCB.

2: Battery Connections

A 12V rechargeable battery must be connected to these terminals in order to provide continuous system operation in the event of an AC Mains failure (see page9).

3: External Sounder Connections

These terminals are used for connecting to an external sounder unit (see page 10 for wiring details).

4: Loudspeaker Connections

These terminals can be used for connecting up to one 16Ω or two 8Ω loudspeakers (see page 12).

5: Auxiliary 12V Connections

These terminals are for connecting devices that require 12V power.

6: SW+ Connections

This terminal is normally used for connecting to latching detectors that require either a latch signal or a removal of power to reset them (see page 20 for details).

7: Auxiliary Tamper Connections

These terminals can be used for monitoring the box tamper of auxiliary devices such as power supplies etc. (see page 12).

8: Keypad Network Connections

These terminals provide connection for the keypads. The '+' and '-' terminals provide power whilst the 'T' transmits data and 'R' receives data (see page 9).

9: Programmable Zones 1 - 8

These terminals provide the connections for the 8 zones (see page 10). Each zone is also fully programmable (see page 21).

10: Box Tamper Switch

This switch provides tamper protection for the main control panel in case of unauthorised access. To disable the box tamper, fit a jumper link across the box tamper pins (if fitted).

11: Low Volume Control

This variable resistor controls the volume level of advisory (entry/exit) tones (turn anticlockwise to increase volume).

12: Power Indicator

This LED will be ON when AC mains is present on the control panel and will flash when there is no AC mains present on the control panel.

F1 - F5: Protection Fuses

The following fuses are provided:

Fuse	Description	Rating
F1	Battery	1 Amp
F2	Auxiliary 12V and Speaker	500mA
F3	Bell and Strobe	1 Amp
F4	Keypad Network	500mA
F5	Power Supply	1.6 Amp

Veritas 8Compact Control Panel PCB Layout

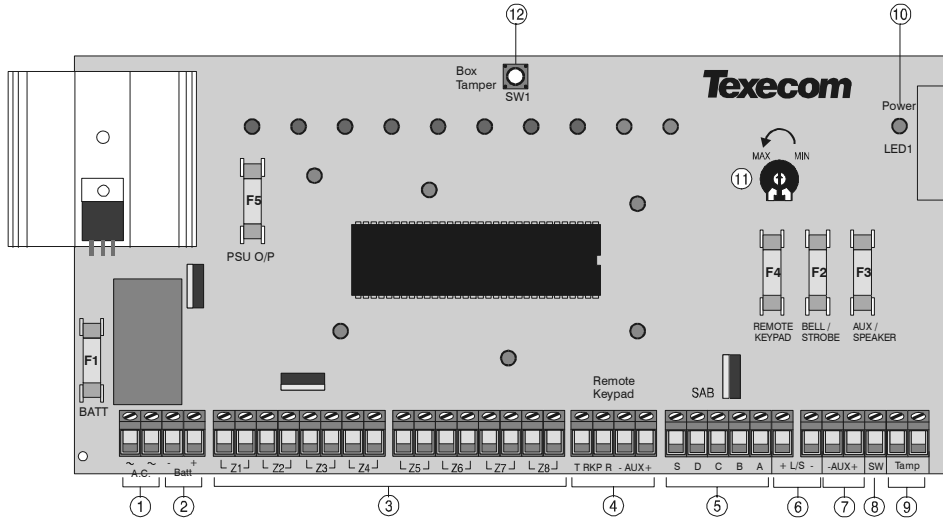

1: AC Input

Connected to the 16.5V transformer.

! DO NOT CONNECT THE MAINS SUPPLY TO THE AC INPUT TERMINALS ON THE PCB.

2: Battery Connections

A 12V rechargeable battery must be connected to these terminals in order to provide continuous system operation in the event of an AC Mains failure (see page 9).

3: Programmable Zones 1 - 8

These terminals provide the connections for the 8 zones (see page 10). Each zone is also fully programmable (see page 21).

4: Keypad Network Connections

These terminals provide connection for the keypads. The '+' and '-' terminals provide power whilst the 'T' transmits data and 'R' receives data (see page 9).

5: External Sounder Connections

These terminals are used for connecting to an external sounder unit (see page 10 for wiring details).

6: Loudspeaker Connections

These terminals can be used for connecting up to one 16Ω or two 8Ω loudspeakers (see page 12).

7: Auxiliary 12V Connections

These terminals are for connecting devices that require 12V power.

8: SW Connections

This terminal is normally used for connecting to latching detectors that require either a latch signal or a removal of power to reset them (see page 20 for details).

9: Auxiliary Tamper Connections

These terminals can be used for monitoring the box tamper of auxiliary devices such as power supplies etc. (see page 12).

10: Power Indicator

This LED will be ON when AC mains is present on the control panel and will flash when there is no AC mains present on the control panel.

11: Low Volume Control

This variable resistor controls the volume level of advisory (entry/exit) tones (turn anticlockwise to increase volume).

12: Box Tamper Switch

This switch provides tamper protection for the main control panel in case of unauthorised access. To disable the box tamper, fit a jumper link across the box tamper pins (if fitted).

F1 - F5: Protection Fuses

The following fuses are provided:

Fuse	Description	Rating
F1	Battery	1 Amp
F2	Auxiliary 12V and Speaker	500mA
F3	Bell and Strobe	1 Amp
F4	Keypad Network	500mA
F5	Power Supply	1.6 Amp

Connecting AC Mains

The AC Mains supply is connected to a 3 way 'Euro Type' fused terminal block, which is fitted with a fuse (see page 27).

NOTE All other wiring MUST be carried out before AC mains is connected to the control panel.

After connecting the AC Mains, fit the mains cover, this can be found in the spares bag.

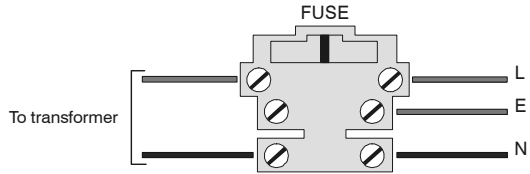

Connecting Batteries

Up to one 12V 2.1Ah battery can be fitted inside a *Veritas 8Compact* and up to one 12V 7Ah battery can be fitted inside a *Veritas 8* or *R8* control panel to provide continued operation in the event of an AC mains failure.

NOTE All other wiring MUST be carried out before the battery is connected to the control panel.

Connect the red battery lead to the positive terminal of the battery and then connect the black battery lead to the negative terminal.

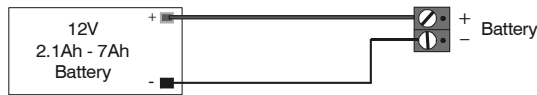

Installing Remote Keypads

A maximum of 6 remote keypads can be connected to the keypad network. The *Veritas 8*, *Veritas 8Compact* and the *Veritas R8* only supports LED keypads.

The networks are made up of four terminals incorporating power and data. To ensure correct operation, all four terminals on the device must be connected to the corresponding terminals on the control panel, or previous keypad. The table below shows each terminal and its description:

Terminal	Description
+	+12V Supply
-	0V Supply
T	Transmit Data
R	Receive Data

Devices can be connected using 4-core cable. However, it is recommended that 6 or 8-core cable is used as the spare cores can be used to 'Double Up' on the power connections if needed.

NOTE Standard 7/0.2 alarm cable can be used for most installations. However, under certain conditions it may be necessary to use screened cable.

Cable Distances

The maximum recommended distance for devices when using standard 7/0.2 alarm cable is:

- 100m for each branch when using the star (parallel) configuration
- When using a daisy chain (series) configuration the maximum distance will depend on the number of devices connected on the chain. The more devices that are connected, the shorter the distance to the last device (this is due to voltage drop in the cable)

Whichever method of wiring configuration is used, ensure that the voltage between the '+' and '-' terminals at each device is no lower than 10.0V when the system is running on the standby battery.

Keypad Addressing

Each keypad MUST be given a different address using the DIP switch on the PCB as follows:

Address	DIP 1	DIP 2	DIP 3	DIP 4	
1	N/A	Off	Off	Off	
2	N/A	Off	Off	On	
3	N/A	Off	On	Off	
4	N/A	Off	On	On	
5	N/A	On	Off	Off	
6	N/A	On	Off	On	

NOTE NEVER set two RKPs to the same address.

Keypads are factory set to Address 1.

If the keypad is powered but offline (i.e. T and R not connected) it will display its address.

If an invalid address is selected, the keypad will sound an error tone.

Configuring the Keypads

When the system is powered up it automatically checks and configures all connected keypads. It is strongly recommended that the system is completely powered down (mains and battery) before wiring a keypad. If a keypad is added without removing power then it must be configured (see page 21).

NOTE If an RKP is configured but off-line, the system will have a tamper fault.

Zone Connections

Detection devices such as PIR's, Door Contacts, PA Buttons etc. are all connected to the 8 zone terminals on the *Veritas R8 Plus* and *Veritas Excel* control panel.

 **NOTE** If a zone is not being used it should be either linked out or disabled (see page 25).

Magnetic Contacts and Panic Buttons

These are connected to one of the eight terminal pairs labelled Z1 to Z8 on the control panel.

Figure 1 - Wiring Magnetic Contacts

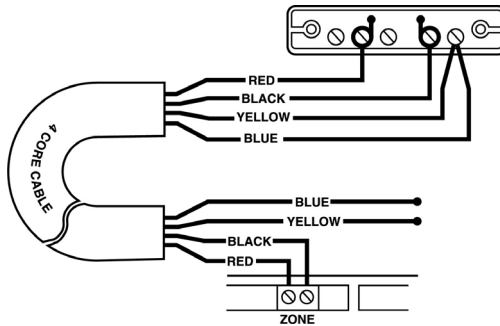

Figure 1a - Wiring a Single Magnetic Contact to a Zone (see also Figure 3).

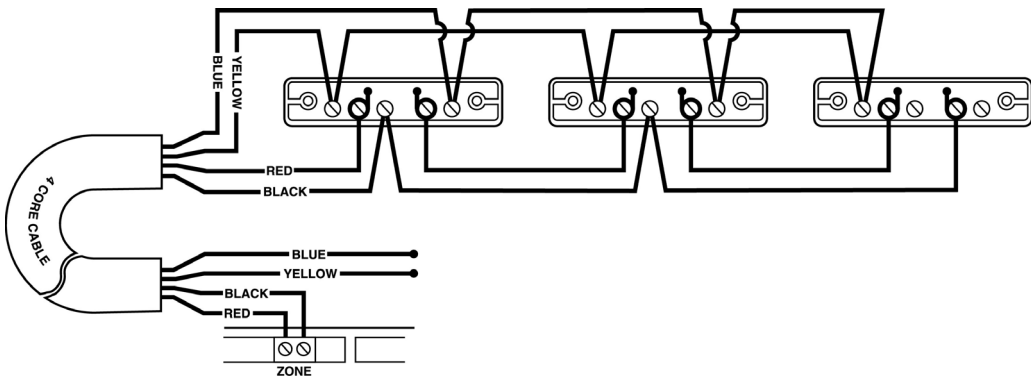



Figure 1b - Wiring Multiple Magnetic Contacts to a Zone (see also Figure 3).

 **NOTE** Mixing powered detectors and magnetic contacts on one zone is easiest if the wiring is taken from the control panel to the powered detectors first.

Powered Detectors

Always consult the manufacturer's connection instructions. Powered detectors are connected to one of the eight terminal pairs labelled Z1 to Z8 on the control panel and are powered from the two terminals labelled AUX on the control panel as follows:

Terminal	Connect To	Suggested Colour
AUX+	Detector Positive Supply (+12V)	White
AUX-	Detector Negative Supply (0V)	Green

Figure 2 - Wiring Powered Detectors

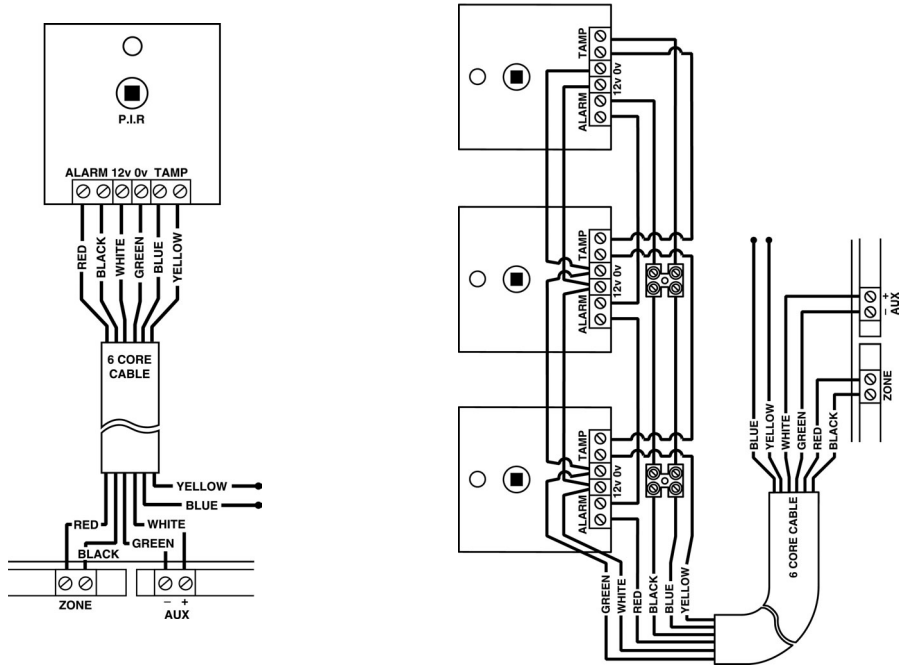

Figure 2a - Wiring a Single Powered Detector to a Zone (see also Figure 3).

Figure 2b - Wiring Multiple Powered Detectors to a Zone (see also Figure 3).



Power is wired in parallel, whereas normally closed alarm loops are wired in series, (normally open alarm loops are wired in parallel).

Mixing powered detectors and magnetic contacts on one zone is easiest if the wiring is taken from the control panel to the powered detectors first.

BS 4737 requires that if two or more powered detectors are connected to one zone, they must each have an audible or visual latching indication or both, except on an entry/exit route.

Global System Tamper

This is connected to the terminal pair labelled TAMP on the control panel. All the individual zone tamper loops should be wired in series.

Figure 3 - Wiring the Global System Tamper

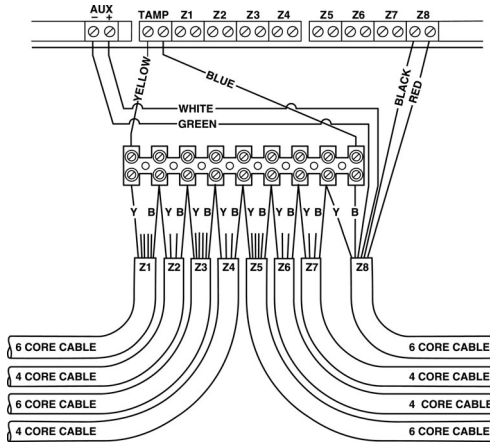

NOTE The control panel is supplied with a link fitted across the Global System Tamper to simulate a closed circuit. This link would usually be removed during installation.

Speaker Connections

This output can be used for driving up to one 16Ω or two 8Ω loudspeakers as shown below:

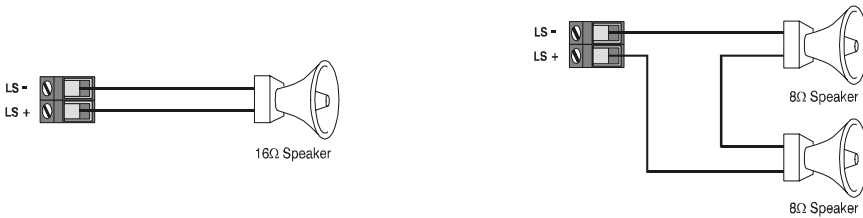

NOTE The total load including the built-in speaker must not be less than 16Ω (e.g. 1 x 16Ω speaker, 2 x 8Ω speakers in series, etc.). The polarity of extension speakers is usually unimportant, however, the polarity of the L/S terminals is indicated by a + and -.

Internal Siren(s)

If required these are connected to two of the external sounder connections, in addition to the external sounder, as follows:

Terminal	Connect To
A	Siren Positive Supply (+12V)
B	Siren Negative Activate/Negative Supply (0V)

Wiring the External Sounder

Always consult the manufacturer's connection instructions. The external sounder and strobe are connected to the five terminals labelled SAB on the control panel as follows:

Terminal	Description
A	Permanent Positive Supply (+12V)
B	Switched Negative to Activate Sounder
C	Negative Tamper Return
D	Permanent Negative Supply (0V)
S	Switched Negative to Activate Strobe

Figure 4 - Typical SAB Connections

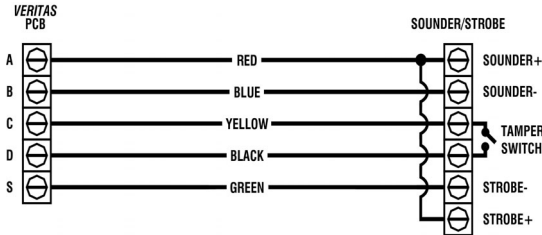

An external sounder is often referred to as a 'bell' or 'bell-box' even when it is actually an electronic siren.

The control panel is supplied with a link fitted across the Bell Tamper to simulate a closed circuit. This link would usually be removed during installation.

If the strobe is a separate unit take the strobe positive supply from 'A' as well.

A self-activating bell/sounder (SAB) has a built-in battery. After connecting this battery the sounder may sometimes sound until its cover is fitted and it is supplied with power from the control panel.

Terminal B may be programmed as switched negative removed rather than switched negative applied to activate sounder (see page 21). This is useful for SCBs where B would then be used to provide the permanent negative supply.

Popular SAB Wiring Diagrams

The following diagrams illustrate how to connect the control panel to the most popular makes of SAB:

Figure 5 - Common SAB Connections

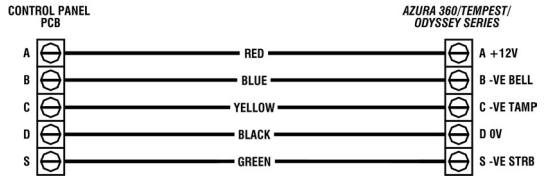

Figure 5a - Texcom Azura 360/Tempest/Odyssey.

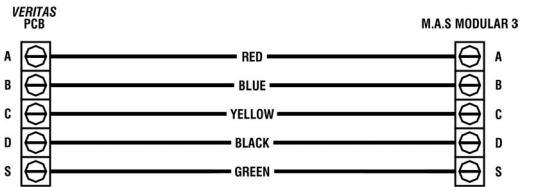

Figure 5b - MAS Modular 3.

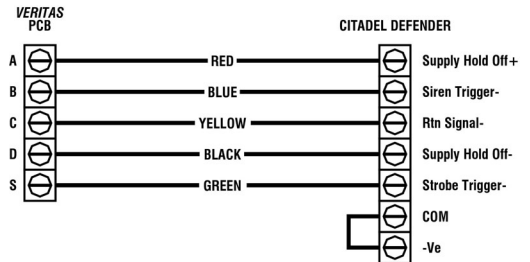

Figure 5c - Citadel Defender.

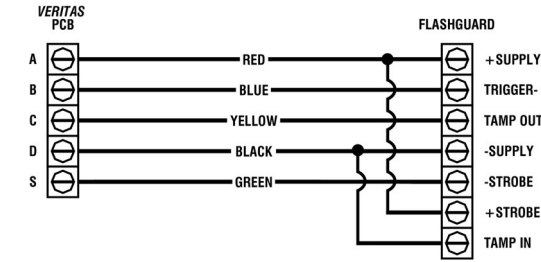

Figure 5d - Volumatic Flashguard.

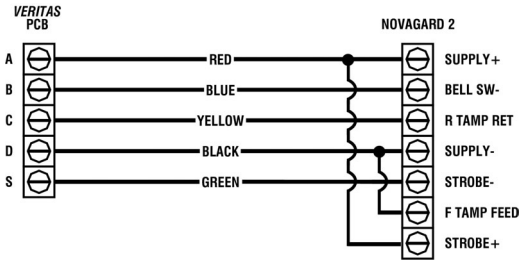

Figure 5e - Gardtech Novagard 2.

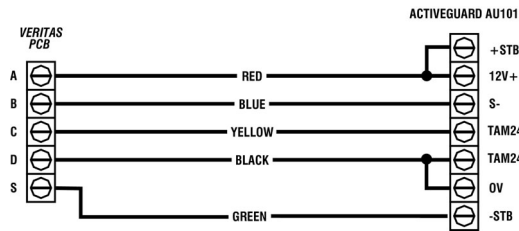

Figure 5f - Activeguard AU101.

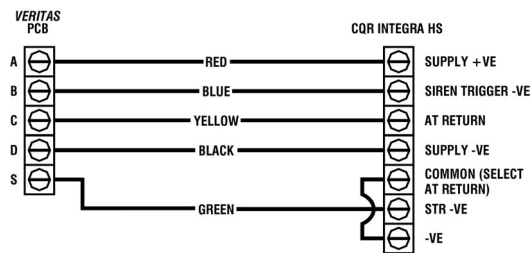

Figure 5g - CQR Integra HS.

Commissioning (Initial Power Up)

ALWAYS Ensure the mains is off BEFORE removing the front cover

- Connect the black battery lead to the negative (-) terminal of the standby battery and the red battery lead to the positive (+) terminal of the standby battery. All the indicator lights will come on. After 10 seconds the zone lights will turn off and a repeating 9 bleep error tone will start.



If the battery is flat or faulty the RKP may not accept key presses.

To Load Factory Settings

Apply power to the control panel and press **RESET** OR press and release the lid tamper spring 3 times BEFORE the zone lights turn off and the repeating 9 bleep error tone starts

- Enter the factory set User code ④③②①. The error tone will stop.
- Enter the factory set Engineer code ①②③④ and press **PROG.** to access the Programming Menu and disable 24 Hour zones (Fire, PA and Tamper) via the Engineer code. All the zone lights will illuminate.
- Perform a Walk Test as described in on page 20. Remember that some powered detectors (e.g. PIRs and Combined Technology Detectors) take several minutes to warm up and become operational.
- Test the internal sounder, external sounder and strobe as described on page 19. To adjust the low-level volume use the control 'pot' on the PCB (see page 7), volume increases anti-clockwise. If the system fails to operate as expected check that the mounting and wiring are as per the instructions.
- Correct any mistakes and repeat the test (see page 15, Trouble Shooting).
- Replace the lid and secure with the two lid screws supplied - **do not over-tighten.**
- Fit the screw covers, these can be found in the spares bag.
- Press **RESET** to leave the Programming Menu. All the zone lights will turn off.
- The Power light will be flashing to indicate that action is required. Switch on the mains supply to the control panel. The Power light will stop flashing and stay on continuously. If the factory settings (see page 3) are not appropriate then re-program the system as described on see page 17.
- If you have a meter:
 - Disconnect the battery & check the total non-alarm current is less than 1A.
 - Reconnect the battery & check the total alarm current is not more than 1A.
- The total current is measured as follows:
 - Set your meter to DC current.
 - Connect your meter across F5 (power supply fuse).
 - Remove F5 and Record the current drain.
 - Replace F5 and Remove your meter.



To avoid accidentally powering down the system be sure to follow **all** the above steps **in order**.

Installation is now complete and the system is ready for use.



When the system is full set, after the exit period, the external strobe will flash for approximately 6 seconds (this option can be de-selected, see page 18).

Servicing the System

ALWAYS Ensure the mains is off BEFORE removing the front cover



The Power light on the control panel is a status indicator for the battery charging circuit, a steady light meaning normal. A flashing light means action required - **mains power can still be present**. ALWAYS use a suitable mains test instrument to confirm that mains power is no longer present.

The transformer and heatsink may be hot during and after use - do NOT touch.

- Test the internal sounder, external sounder and strobe as described on page 19. Perform a Walk Test as described on page 20. Basic Log events may be viewed by following the procedure described on page 25.
- If it is necessary to remove the lid, first switch off the mains supply to the control panel. Ensure that the Power light is flashing, then use a suitable mains test instrument to confirm mains power is no longer present.
- **Enter the 4 digit Engineer code ? ? ? ? and press (PROG.)** to access the Programming Menu and disable 24 Hour zones via the Engineer code. All the zone lights will illuminate.
- Remove the screw covers by inserting a screwdriver into the screw cover slot and turning anti-clockwise whilst applying pressure outwards.
- Unscrew the lid screws and remove the lid.
- On completion replace the lid and secure with the lid screws - **do not over-tighten**.
- Replace the screw covers.
- **Press (RESET)** to leave the Programming Menu. All the zone lights will turn off.
- Switch on the mains supply to the control panel. The Power light will stop flashing and stay on continuously.

Trouble Shooting

ALWAYS Ensure the mains is off BEFORE removing the front cover



When replacing a fuse always observe the specified rating and type - failure to do so is dangerous and will invalidate the warranty. Fuses should comply with IEC 127.

No Power to the Unit (Mains Only)

- Check the mains block fuse and replace if blown.
- Check for any loose wires at the mains block, the transformer and the AC terminals on the PCB.
- Check the mains block is connected correctly; live to live (brown), neutral to neutral (blue).

No Power to the Unit (Battery Only)

- Check the battery fuse F1 and replace if blown.
- Check for any loose wires at the BATT terminals on the PCB.
- Check that the battery wires are connected correctly; red from BATT+ to the battery positive (+), black from BATT- to the battery negative (-).

No Power to the Unit (Mains & Battery)

- Check the power supply output fuse F5 and replace if blown.
- Disconnect all wires from the control panel SAB A and AUX+ terminals.
- Check that links are only fitted in the correct places.
- Check there are no wires shorting to the underside of the PCB.
- Repeated blowing of the battery fuse F1 may indicate a faulty battery.

Unit Does Not Accept Code

- If using more than one RKP, check that each RKP has a different address.
- If using one or more RKPs, check that they are wired correctly.
- If the remote keypad was connected after the control panel was powered up, disconnect all power momentarily and reconnect. This automatically configures all remote keypads on the system, (also see page 21).
- Check you are using the correct codes. Factory-set Engineer code is ①②③④. Factory-set User code is ④③②①.
- If using one or more RKPs on battery only, try using mains as the battery may be flat.
- Check that the codes have not been changed. If the codes have been lost (see page 20).
- Check that the membrane keypad tail is all the way home in its connector on the PCB.

Unit Will Not Set and Bleeps 10 Times

The Power light on the panel will be flashing to indicate a power fault, either mains fail or battery low volts.

- The mains frequency may be set incorrectly (see page 19).
- The procedure for setting the system in the event of a power fault is described in the User Guide.

Unit Will Not Set and Bleeps 9 Times

The system has a tamper fault and the Tamper light will be on. Using the extended display during Walk Test (see page 20) identify the cause of the tamper fault:

- If the extended display identifies the fault as bell box tamper, then the cause may either be Bell Tamper or Global System Tamper. Temporarily replace the system tamper link (TAMP):
 - If the tamper fault persists then it is due to the Bell Tamper - check the bell wiring, the bell lid and/or screw tamper, and the bell wall tamper (if fitted).
 - If the tamper fault clears then it is due to the system tamper. Remove the system tamper link and the tamper fault will reappear - check the system tamper wiring and the lid tamper on all detectors.
- **Remove ALL Temporary Links.**
- If the extended display identifies the fault as lid tamper, it may refer either to the control panel or the remote keypad(s). Try stretching the springs and ensure all connections are secure.
- To set the system with a tamper fault use the following procedure:
 - **Enter the User code** **???**. Press **FULL** or **PART**. The system will sound a repeating series of 9 bleeps. Press **CHIME**. The display will illuminate the zones that are about to be armed. Press **9**. The Tamper light will turn off. Press **PROG**. The exit tone and exit timer will start.
- To prevent repeated false alarms due to an intermittent tamper fault when the system is unset, omit Tamper as described above, then abort the setting procedure by re-entering the User code.
- To prevent Tamper from being omitted (see page 18).

Unit Will Not Set and Bleeps 1 - 8 Times

The system has one or more zone faults and the corresponding zone light(s) will be on.

- Ensure that the zone is closed (doors shut, no movement in PIR detection area).
- Check the zone wiring and ensure all connections are secure.
- Check that detectors are powered correctly (i.e. correct polarity).

Unit Goes Into False Alarm

- Check that the terminal screws are fully down on all terminals **but do not over tighten**.
- If you have a meter use it to check the loop resistance (wires that run under carpets are easily damaged).

Unit Makes No Sound

- Check that the variable resistor (pot) on the PCB which controls the volume of low level tones is NOT turned fully clockwise. The volume increases as the pot is turned anti-clockwise.
- Check the auxiliary fuse F3 and replace if blown.
- Check the speaker connections to the L/S terminals on the PCB.

System Operates but Keypad Makes No Sound

- If an older version remote keypad has been fitted the system must be programmed for old style sounds as follows: **Enter the Engineer code** **???**, press **PROG**, enter **00**, press **8**, press **PROG**, press **RESET**.

External Sounder/Strobe Does Not Work

- Check wiring connections by referring to the diagrams on page 13.
- Check the bell/strobe fuse F2 and replace if blown.
- To check the external sounder make a temporary connection between SAB B and D.
- To check the strobe make a temporary connection between SAB S and D.

The Panic Button Does Not Work

- Check that the Zone Type of the zone to which the panic button is connected is programmed as PA (see page 22).
- Check that the zone to which the panic button is connected is not omitted in part set (see page 26).
- Check that the Zone Type of the zone to which the panic button is connected is not changed in part set (see page 22).
- Older version remote keypads do NOT support Keypad PA (pressing **3** and **9** together), see System Operates but Makes No Sound, above.

Service Timers Cannot Be Programmed

Programming the service timers (**27**, **28**, **29**) is prevented unless the current date (**25**) has been programmed since the last power-up (see page 23).

4. Programming the Control Panel

Introduction

Programming is usually unnecessary as the factory settings have been carefully selected to suit most installations without alteration. However all functions are fully programmable for Complete Control.

The Programming Menu

The Programming Menu can only be accessed when the control panel is unset.

The display will normally look like this:



Enter your 4-digit Engineer code (factory set to ①②③④). The display will look like this:



If no keys are pressed, the display will revert back to normal after 16 seconds.

Press **(PROG.)**, the display will look like this:



The various programming options are then selected by entering a 2-digit Option code (②)(?). The Programming Procedure then depends upon the programming option selected as detailed in the following sections. On completion, each programming option reverts to the Programming Menu, allowing other programming options to be accessed. To exit the Programming Menu **press (RESET)**, the system will revert to unset.



To abort programming at any stage (and preserve the original setting) press **(RESET)**, the system will revert to the Programming Menu.

24 Hour zones (Fire, PA and Tamper) are disabled when the Programming Menu is accessed via an Engineer code.

To omit zones, set chime or change the User code, refer to the User Guide.

The system programming is retained even in the event of complete loss of power.

The Miscellaneous Selections ①① - ①③

There are four sets of Miscellaneous Selections that control the behaviour of various system functions.

Miscellaneous Selections Zero ①①

From the Programming Menu, **enter ①①**. The display will show the options currently selected.



Press the appropriate numbered button(s) to select or de-select the corresponding option(s) as shown on the display.

Press **(PROG.)**. The system will chime to confirm that the new options have been accepted. The system will then automatically revert to the Programming Menu.

Option	Miscellaneous Selections Zero	Default
1	Cancel Strobe with Bell	Off
2	Keypad PA, ③ and ⑨	On
3	Single Button Setting	On
4	Silent Part Set Confirmation Tone	Off
5	EN50131-1 Requirements	Off
6	Time Limit Engineer Access	Off
7	Reset Button Cancels Setting	On
8	Old Style Veritas Sounds	Off

Option 1 - Cancel Bell With Strobe

When 'ON' the strobe will stop when the bell timer expires.

Option 2 - Keypad PA, ③ and ⑨

When 'ON' Pressing 3 and 9 together will generate a keypad PA alarm.

Option 3 - Single Button Setting

When 'ON' The system can be set using the **(FULL)** or **(PART)** keys without the need to first enter a User code.

Option 4 - Silent Part Set Confirmation Tone

When 'ON' a confirmation tone is generated to indicate that the alarm has set, Will only function if Silent Part Set (see page 18) is also selected.

Option 5 - EN 50131-1 Requirements

When 'ON' the following features are enabled (see page 28).

- Reset (after an alarm) requires the use of a User code.
- An entry alarm (defined as an entry timeout or, a Guard zone activation during the entry period) invokes a 30 second delay during which the external sounder is suppressed (i.e. the alarm response is limited to the internal sounder(s) and external strobe for the first 30 seconds).
- On unsetting the system the unset light will extinguish after 30 seconds.
- On unsetting the system omitted zones are re-included.

Option 6 - Time Limit Engineer Access

When 'ON' the control panel will only accept Engineer codes for the first 30 seconds after the system is unset (i.e. while the Unset light is on if Option 5 is also selected).

Option 7 - Reset Button Cancels Exit

When 'ON' setting can be aborted by pressing the **(RESET)** button. It is particularly useful if Single Button Setting (Option 3) is selected but may be used independently.

Option 8 - Old Style Veritas Sounds

Must be 'ON' if older version remote keypads are used.

Miscellaneous Selections One

①

From the Programming Menu, enter ①. The display will show the options currently selected.

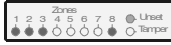

Press the appropriate numbered button to select or de-select the corresponding option as shown on the display.

Press (PROG.). The system will chime to confirm that the new options have been accepted. The system will then automatically revert to the Programming Menu.

Option	Miscellaneous Selections One	Default
1	Internals Only on Unset Tamper Alarm	On
2	Internals Only on Part Set Zone Alarm	On
3	Internals Only on Part Set Tamper Alarm	On
4	Silent Part Set (no exit tone on part set)	Off
5	High Level Chime (chime at full volume)	Off
6	Invert Bell Output	Off
7	Final Door Set	Off
8	Unlock Engineer	On

Option 1 - Internals Only on Unset Tamper Alarm

When 'ON' a tamper alarm when unset will only activate the internal sounders.

Option 2 - Internals Only on Part Set Zone Alarm

When 'ON' an alarm when part set will only activate the internal sounders.

Option 3 - Internals Only on Part Set Tamper Alarm

When 'ON' a tamper alarm when part set will only activate the internal sounders.

Option 4 - Silent Part Set

When 'ON' no exit tones will be heard when the alarm is being part set.

Option 5 - High Level Chime

When 'ON' chime tones are always full volume.

Option 6 - Invert Bell Output

When 'ON' the bell output will be negative removed instead of negative applied.

Option 7 - Final Door Set

When 'ON' the alarm will set 3 seconds after the entry/exit door is closed.

Option 8 - Unlock Engineer Code

When 'ON' Re-loading the Factory Settings WILL restore the default Engineer code. If Option 8 is de-selected (Zone 8 light is off) then Re-loading the Factory Settings WILL NOT restore the default Engineer code.

NOTE Locked Engineer codes cannot be unlocked without the correct Boss Engineer code.

Unlocking a locked Engineer code that has been lost is subject to a minimum charge.

Disclaimer

It is the responsibility of the Installer to guard against losing locked Engineer codes. Texecom accept no liability whatsoever for any loss resulting from locked Engineer codes.

Miscellaneous Selections Two

②

From the Programming Menu, enter ②. The display will show the options currently selected.



Press the appropriate numbered button to select or de-select the corresponding option as shown on the display.

Press (PROG.). The system will chime to confirm the new options have been accepted. The system will then automatically revert to the Programming Menu.

Option	Miscellaneous Selections Two	Default
1	Engineer Reset on Any Alarm	Off
2	Engineer Reset on Tamper Alarm	Off
3	Disable User Ability to Omit Tamper	Off
4	Code PIN Tamper	Off
5	Random Number Remote Reset	Off
6	Push To Set	Off
7	Strobe Flash on Full Set	On
8	Invert Switched Positive Output	Off

Option 1 - Engineer Reset on Any Alarm

When 'ON' the user is prevented from resetting the system after an alarm activation.

Engineer Reset can be cleared by:

- Entering an Engineer code
- Entering an RNRR code (if selected - Option 5)

NOTE Engineer Reset is not in itself a method of resetting the system a subsequent User Reset will still be required as follows:

After an Alarm has been Silenced:

- Pressing (RESET) (unless EN 50131-1 Requirements is selected - see page 17)
- Entering a User code

At other times:

- Entering a User code and pressing (RESET)

NOTE When an Engineer Reset is required the user can still silence the alarm and cancel the strobe but cannot reset the system.

RNRR and Remote Reset are methods of clearing Engineer Reset. They will not function unless at least one Engineer Reset is selected.

Option 2 - Tamper Alarm Engineer Reset

When 'ON' the user is prevented from resetting the system after a tamper alarm has occurred (for details on Engineer Reset see Option 1).

Option 3 - Disable User Ability to Omit Tamper

When 'ON' users cannot omit tampers.

Option 4 - Code PIN Tamper

When 'ON' a tamper alarm is generated after 16 invalid key presses when unset.

Option 5 - Random Number Remote Reset

When 'ON' Random Number Remote Reset is enabled.

- If RNRR (sometimes called Anti-Code Reset or Scramble Reset) is enabled and an Engineer Reset is required, a random 4-digit number will be displayed.



LED Keypad - Each digit will flash in turn and then pause before repeating.

Texecom's Anti-Code software will accept this sequence to generate a 4-digit code, which should be entered, after which the system can be reset as normal. Anti-Code software is available from Texecom.

The user can press **(RESET)** to toggle between the RNRR and the alarm display.

The User Guide has a section to fill in the phone number(s) where the user may obtain the Anti-Code.

Random Number Remote Reset satisfies the requirements of NACP 10, Issue 2, Section 11.2b.

Option 6 - Push To Set

The user starts full set in the usual way and leaves the premises. However the system will ONLY set when an external push button is pressed.



Ensure the zone is set as Push to Set (see page 21).

If this zone is set to chime (see User Guide) then the push button can double up as a door bell.

Push to Set does not operate in part set.

Option 7 - Strobe Flash on Full Set

When 'ON' the external strobe will flash momentarily to indicate that the alarm has set.

Option 8 - Invert Switched Positive Output

When 'ON' the operation of the Switched Positive output (SW+) is inverted.

Miscellaneous Selections Three ① ③

From the Programming Menu, enter **① ③**. The display will show the options currently selected.



Press the appropriate numbered button to select or de-select the corresponding option as shown on the display.

Press **(PROG.)**. The system will chime to confirm that the new options have been accepted. The system will then automatically revert to the Programming Menu.

Option	Miscellaneous Selections Three	Default
1	Mains Frequency (off = 50Hz, on = 60Hz)	Off
2	Reserved for Future Use	Off
3	Reserved for Future Use	Off
4	Reserved for Future Use	Off
5	Reserved for Future Use	Off
6	Reserved for Future Use	Off
7	Reserved for Future Use	Off
8	Reserved for Future Use	Off

Option 1 - Mains Frequency

When 'OFF' the Mains frequency is set to 50Hz (UK).



If the wrong Mains Frequency is selected the panel will indicate a power fault.

Option 2 - 8 Reserved For Future Use

For details see page 11.

Number of Alarm Activations (Re-arms) ① ④

From the Programming Menu, enter **① ④**. The display will look like this.



Enter the desired number of Alarm Activations as a two digit number (e.g. for three Activations, enter **① ③**). The display will indicate as each digit is entered. Press **(PROG.)**. The control panel will chime to confirm that the new number of Activations has been accepted. The system will then automatically revert to the Programming Menu.



The total number of Activations should not be less than 01.

Testing the Sounders, Strobe ① ⑤

From the Programming Menu, enter **① ⑤**. The display will look like this.



The system outputs may be tested as follows:

Key	Function
⑥	Invoke Texecom bell box hold-off mode
⑤	Toggle the SW+ output
④	Toggle the internal sounder high level (alarm tone)
③	Toggle the internal sounder low level (entry/exit tone)
②	Toggle the strobe output
①	Toggle the external sounder (bell) output
①	Turn off all of the above



The zone corresponding to each output will be displayed when it is on.

All Texecom bell boxes feature a unique, patented "Engineer Hold-Off Mode" which disables Self-Activate on Lid Tamper to facilitate convenient servicing. Option **⑥** will cause the strobe output to pulse 3 times to invoke Hold-Off Mode. Zone 2 will flash to indicate the strobe pulsing after which Zone 6 will indicate that Hold-Off Mode has been invoked. (See bell box instructions for more details).

Press **(RESET)** to return to the Programming Menu.

Walk Testing ①⑥ or ①⑨

The control panel has two Walk Test modes, Latching and Non-Latching. During Walk Test when any zone is opened the corresponding zone will indicate. When the zone is closed the zone indication will clear in Non-Latching Walk Test, but will remain on in Latching Walk Test.

From the Programming Menu, enter ①⑥ to select Non-Latching Walk Test, or ①⑨ to select Latching Walk Test followed by (PROG).



Initially all the zone indicators will be off and the control panel will sound the quiet exit tone. When any zone is opened, the corresponding zone will indicate. The control panel will, in addition, sound a repeating series of beeps corresponding to the open zone number (i.e. Zone 1 beeps once, Zone 2 beeps twice, etc.). If more than one zone is open, the beeps will correspond to the highest zone number (e.g. if Zone 2 and Zone 6 are open, the control panel will beep 6 times).

Conduct a Walk Test by triggering each of the system's detection devices in turn and check that the control panel registers the corresponding zone as open.

NOTE If the Tamper indicator is on and the panel beeps 9 times an extended display reveals more information about the source of the tamper fault(s). To toggle between the normal display and the extended display press (MEM). The extended display is distinguished from the normal display by the Unset light being off. In the extended display the zones are interpreted as follows:

Zone	Description
1	Bell Tamper (including Global System Tamper)
2	Not Applicable
3	Lid Tamper (including RKP Lid Tamper)
4	Not Applicable
5	RKP Off-Line
6	Not Applicable
7	Not Applicable
8	Not Applicable

To terminate Walk Test press (RESET). The system will return to the Programming Menu.

Re-Loading the Factory Settings ①⑦

From the Programming Menu, enter ①⑦. The display will look like this.



Press (PROG). The system will chime to confirm that all the factory settings have been re-loaded into the Non Volatile Memory. The system will then automatically revert to the Programming Menu.

If the Engineer code has been lost, provided it has not been locked (see page 18) power down the system (mains and battery). Restore power. The display will look like this for 10 seconds.



Press (RESET), or SLOWLY press and release the panel lid tamper spring 3 times, before this display changes. The factory settings have now been re-loaded into the Non Volatile Memory.

NOTE Unlocking a locked Engineer code that has been lost is subject to a minimum charge.

Re-loading factory settings will not clear the Event Log (see page 25).

The system will bleep each time the panel lid tamper spring is pressed and released during the first 10 seconds after power up.

Programming the SW+ Output ①⑧

From the Programming Menu, enter ①⑧. The display will show the option currently selected.



Press the number of the function required from the following list. Press (PROG).

The system will chime to confirm the new function has been accepted. The system will automatically revert to the Programming Menu.

Option	SW+ Function
1	Set Positive (latching detectors)
2	Alarm Positive with Latching Sensor Reset (FTA detectors)
3	Latching Shock Sensor Auto-Reset (old style latching shock sensors)
4	Tamper
5	Mains Fail
6	Set Positive with Latching Sensor Reset (latching detectors)
7	Walk Test
8	Entry/Exit

If connecting multiple detectors to one zone then:

- Latching detectors will indicate which detector(s) activated during an alarm.
- First to Alarm (FTA) detectors will indicate which detector caused an alarm and which detectors were then activated during the alarm.

Option 3 would typically be used with older designs of latching shock sensor which do not have a Latch input and must be powered down to clear the Latch indication. In this case the detectors would be powered from the SW+ output.

NOTE If selecting one of the options which incorporate latching sensor reset (2, 3 or 6) the user can force a latching sensor reset, to clear the Latch/FTA indication, by entering their code and pressing (RESET).

The SW+ output can only sink (not source) current. If powering detectors from the SW+ output, connect the detector +Ve to AUX+ and the detector -Ve to SW+. It may be necessary to invert the SW+ polarity (see page 18).

Configuring Remote Keypads ⑩ ⑨

Each keypad MUST be given a different address using the DIP switch on the PCB as follows:

Address	DIP 1	DIP 2	DIP 3	DIP 4
1	N/A	Off	Off	Off
2	N/A	Off	Off	On
3	N/A	Off	On	Off
4	N/A	Off	On	On
5	N/A	On	Off	Off
6	N/A	On	Off	On



NEVER set two RKPs to the same address.

Keypads are factory set to Address 1.

If the keypad is powered but offline (i.e. T and R not connected) it will display its address.

If an invalid address is selected, the keypad will sound an error tone.

From the Programming Menu, **enter** ⑩ ⑨. The display will show the zone numbers corresponding to remote keypads (RKPs) that are currently configured and on-line, while flashing the zone numbers corresponding to RKPs that are currently configured but off-line.



To update the configuration, **press** (PROG.). The control panel will scan for RKP addresses 1 to 6. As each RKP is detected the control panel will configure it as present and show the zone number corresponding to its address.

To leave configuring, **press** (RESET). If the configuration has not been updated the panel will sound an error tone. The system will automatically revert to the Programming Menu.



NEVER set two RKPs to the same address.

Setting the address of an RKP is described in the remote keypad instructions.

If an RKP is configured but off-line the system will have a tamper fault.

ALWAYS power down the control panel when wiring a remote keypad (RKP).

If an older version remote keypad has been fitted the system must be programmed for old style sounds as follows: **Enter the Engineer code** ② ② ② ②, **press** (PROG.), **enter** ⑩ ⑩, **press** ⑧, **press** (PROG.), **press** (RESET).

Programming Zone Types ① ① - ① ⑧

The Zone Type of a zone determines how the system will behave when the zone is opened.

Description of Zone Types

The Control Panel supports eight different Zone Types. Each zone may be programmed with one of these Zone Types which are described as follows:

Push To Set

Push to Set is intended to reduce false alarms due to user error when full setting the system. The user starts full set in the usual way and leaves the premises. However the system will ONLY set when an external push button is pressed. The Zone Type of the zone to which the external push button is connected must be programmed as Push to Set.



The Push to Set option must also be selected (see page 19, Option 6).

If the zone is set to chime (see User Guide) then the push button can double up as a doorbell.

The external push button should be waterproof unless it is located in an enclosed porch.

Push to Set does not operate in part set.

Push to Set satisfies the requirements of NACP 14, Issue 1, Section 2.1.2.

Inhibited Entry

Inhibited Entry is sometimes referred to as 'Intermediate Entry' or 'Walk Through'. Opening a zone with this Zone Type when the panel is set will cause an alarm. During entry mode, activations of a zone with this Zone Type are disregarded. This Zone Type would typically be used for a hall PIR when there is a magnetic contact on the front door.

Guard

Guard zones are sometimes referred to as 'Intruder' zones. Opening a zone with this Zone Type when the system is set will cause an alarm. When the control panel is unset, Guard zones are ignored. In a typical system most zones would have this Zone Type.

Fire

This Zone Type is designed specifically for smoke detectors. Zones with this Zone Type are monitored constantly even when the panel is unset. If activated they will cause a unique alarm with a distinctive 'Fire' tone on the internal speaker. In addition, the external sounder will be pulsed rather than sounding continuously in contrast to a normal alarm.

Tamper

Zones with this Zone Type are monitored constantly even when the panel is unset. If activated they will cause an immediate alarm. The Global System Tamper zone is factory-set to this Zone Type.



Programming options allow the Tamper alarm response to be limited to the internal sounder if the system is unset or part set (see page 18).

Entry/Exit

Opening a zone with this Zone Type when the system is set will cause the control panel to start entry mode. This Zone Type would typically be used for a front door magnetic contact or, if one is not fitted, a hall PIR.



The Final Door Set option (see page 18) will cause the exit time to be reduced to 3 seconds when an Entry/Exit zone is closed during exit mode. This option would typically be used only when there is a magnetic contact on the front door.

Personal Attack

This Zone Type is designed specifically for panic buttons. Zones with this Zone Type are monitored constantly even when the panel is unset. If activated, they will cause an immediate alarm, sounding both the internal and external sounders.

Keyswitch

This Zone Type is designed specifically for key switches. Zones with this Zone Type are monitored constantly. The key switch can be used to full set, unset, silence an alarm and reset the system.

 Ensure that there are no 24 Hour zones (Fire, PA and Tamper) in fault when using a key switch to reset the system.

A Keyswitch zone as follows:

Activating the zone i.e. closed to open will cause the system to set and clearing the zone again i.e. open to closed will cause the system to unset.

PA codes, Duress codes and Keypad PA are entered from a keypad and therefore cannot be reset by a key switch but only by entry of a valid User code.

24 Hour Zone Types

24 Hour zones (Fire, PA and Tamper), Keyswitch zones and Push to Set zones should be monitored constantly.

When a zone is omitted the system no longer monitors opening and closing of that zone. The Full and Part Set Suites (see page 25) provide a method of automatically omitting zones when the system is set. Once a zone is omitted it will not be re-included until the system is next set. It is important to ensure that 24 Hour zones (Fire, PA and Tamper), Keyswitch zones and Push to Set zones are not omitted by any of the Full or Part Set Suites or the Cleaner Suite.

The system can be programmed to automatically change the Zone Type of any zone into either Exit/Entry, Inhibited Entry or Guard on selected part sets (see page 22). The change will persist until the system is unset. It is important to ensure that 24 Hour zones (Fire, PA and Tamper), Keyswitch zones and Push to Set zones are not changed on part set.

 If EN 50131-1 Requirements is selected (see page 17) then omitted zones will be re-included when the system is next unset.

Programming the Zone Type ①① - ①⑧

Each of the eight Zone Types has an associated Zone Type number which is used when programming the Zone Type of a zone:

Zone Type Number	Zone Type
1	Push To Set
2	Inhibited Entry
3	Guard
4	Fire
5	Tamper
6	Entry/Exit
7	Personal Attack (Panic)
8	Keyswitch

From the Programming Menu, press ① followed by the zone number. The Zone Type currently selected will indicate i.e. Entry/Exit.



Press the Zone Type number required. Press (PROG.). The system will chime to confirm the new Zone Type has been accepted. The system will then automatically revert to the Programming Menu.

For example to program Zone 7 as a Guard zone, enter ①⑦, press ③, press (PROG.).

Key	Description
①	Program Zone Type
⑦	Zone = 7
③	Zone Type = Guard
(PROG.)	Program

 A zone is often referred to by its Zone Type, e.g. a zone with the PA Zone Type would be referred to as a PA zone.

Changing Part Set Zone Types ②① - ②③

The Zone Type of any zone can be made to change when the system is part set. The Zone Type can be changed into either Entry/Exit, Inhibited Entry or Guard. It is also possible to program which part set(s) will cause the Zone Type to change. The change will persist until the system is next unset.

For example, the tables below show the factory settings:

Zone	Zone Type	Part Setting Changes Zone Type Into:		
		Entry/Exit ②①	Inhibited Entry ②②	Guard ②③
1	Entry/Exit			✓
2	Inhibited Entry	✓		
3	Guard			
4	Guard			
5	Guard			
6	Guard			
7	Guard			
8	Guard			

Zone 1 will change (from Entry/Exit) into Guard and Zone 2 will change (from Inhibited Entry) into Entry/Exit.

 24 Hour zones (Fire, PA and Tamper), Keyswitch zones and Push to Set zones should be monitored constantly and should NOT be programmed to change when the system is part set.

Changing Zones to Entry/Exit**②①**

This suite defines the zones which will be changed into Entry/Exit zones on the selected part sets. For example the Control Panel is factory set with Zone 2 included. Thus the Zone Type of Zone 2 will be changed (from Inhibited Entry) into Entry/Exit on Part Set 1.

From the Programming Menu, **enter** **②①**. The zones that are currently included will indicate.

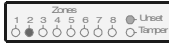

Press the appropriate numbered button(s) of the zone(s) to be included or excluded. Press **PROG.** The system will chime to confirm that the new suite has been accepted. The system will then automatically revert to the Programming Menu.

Changing Zones to Inhibited Entry**②②**

This suite defines the zones which will be changed into Inhibited Entry zones on the selected part sets. For example the Control Panel is factory set with no zones included. Thus no zones will be changed into Inhibited Entry.

From the Programming Menu, **enter** **②②**. The zones that are currently included will indicate.



Press the appropriate numbered button(s) of the zone(s) to be included or excluded. Press **PROG.** The system will chime to confirm that the new suite has been accepted. The system will then automatically revert to the Programming Menu.

Changing Zones to Guard**②③**

This suite defines the zones which will be changed into Guard zones on the selected part sets. For example the Control Panel is factory set with Zone 1 included. Thus the Zone Type of Zone 1 will be changed (from Entry/Exit) into Guard on Part Set 1.

From the Programming Menu, **enter** **②③**. The zones that are currently included will indicate.



Press the appropriate numbered button(s) of the zone(s) to be included or excluded. Press **PROG.** The system will chime to confirm that the new suite has been accepted. The system will then automatically revert to the Programming Menu.

Programming the Date and Time**②⑤ - ②⑥**

It is **ESSENTIAL** to program the current date (**②⑤**) and time (**②⑥**) for correct operation of the service timer(s).

Programming the service timers (**②⑦**, **②⑧**, **②⑨**) is prevented unless the current date (**②⑤**) has first been programmed.

If the panel is completely powered down it will attempt to store the current time and date in NVM and continue from this point when it is powered up. However it may be also desirable to select the Engineer Reset on Power Up option (see page 18).

Programming the Date**②⑤**

From the Programming Menu, **enter** **②⑤**. The display will look like this.



Enter the current date as a 6 digit number; Day, Day, Month, Month, Year, Year (e.g. to program the 1st of June 1998 enter **①①①⑥⑨⑧**). The display will indicate as each digit of the new date is entered. **Press** **PROG.** The system will chime to confirm the new date has been accepted. The system will then automatically revert to the Programming Menu and all the zone lights will illuminate.

Programming the Time**②⑥**

From the Programming Menu, **enter** **②⑥**. The display will look like this.



Enter the current time as a 6 digit number; Hour, Hour, Minute, Minute, Second, Second using 24 hour format (e.g. to program 7 minutes and 3 seconds past 2pm (14:07:03) enter **①④⑦⑦③**). The display will indicate as each digit of the new time is entered. **Press** **PROG.** The system will chime to confirm the new time has been accepted. The system will then automatically revert to the Programming Menu.

Programming the Service Timers ②⑦ - ②⑨

NOTE It is essential to program the current date (②⑤) and time (②⑥) for correct operation of the service timers.

Programming the service timers (②⑦), (②⑧), (②⑨) is prevented unless the current date (②⑤) has first been programmed.

The user can turn off chime globally or on individual zones but where still selected it will remain at high level until reprogrammed by an Engineer.

⚠ Disclaimer:

It is the responsibility of the Installer to obtain prior written agreement from the Customer regarding any use of a Service Timer. Texcom accept no liability whatsoever for any dispute resulting from the use of Service Timers.

The Control Panel features three service timers designed to facilitate the convenient support of service contracts.

Any one, any two, or all three timers can be programmed for the same or different dates. To disable a service timer simply program an invalid or expired date. Expired service timers are automatically cleared when an Engineer code is entered.

Service Timer One - Reminder

Service Timer One is designed to be used as a reminder. When it expires it turns on high level chime on all eight zones the first time the panel is set/unset.

Service Timer Two - Nuisance

Service Timer Two is designed to be used as a nuisance. When it expires it turns on high level chime on all eight zones every time the panel is set/unset.

Service Timer Three - Lockout

Service Timer Three is designed to be used as a lockout. When it expires it will turn chime off and the panel will require an Engineer Reset (see Option 1 page 18 for details on Engineer Reset).

Programming Service Timer One ②⑦

From the Programming Menu, enter ②⑦. The display will look like this.



Enter Service Timer One (Reminder) date as a 6 digit number; Day, Day, Month, Month, Year, Year (e.g. to program the 1st of April 1999 enter ①①①④⑨⑨). The display will indicate as each digit of the new date is entered. Press (PROG). The system will chime to confirm the new date has been accepted. The system will then automatically revert to the Programming.

Programming Service Timer Two ②⑧

From the Programming Menu, enter ②⑧. The display will look like this.



Enter Service Timer Two (Nuisance) date as a 6 digit number; Day, Day, Month, Month, Year, Year (e.g. to program the 25th of December 2000 enter ②⑤①②①①). The display will indicate as each digit of the new date is entered. Press (PROG). The system will chime to confirm the new date has been accepted. The system will then automatically revert to the Programming Menu.

Programming Service Timer Three ②⑨

From the Programming Menu, enter ②⑨. The display will look like this.



Enter Service Timer Three (Lockout) date as a 6 digit number; Day, Day, Month, Month, Year, Year (e.g. to program the 1st of January 2001 enter ①①①①①①). The display will indicate as each digit of the new date is entered. Press (PROG). The system will chime to confirm the new date has been accepted. The system will then automatically revert to the Programming Menu.

Programming System Timers ③① - ③⑨

The system has the following eight time delays and one test time which are all programmable:

No.	Time Delay
①	Full Set Exit Time (seconds)
②	Part Set Exit Time (seconds)
③	Full Set Entry Time (seconds)
④	Part Set Entry Time (seconds)
⑤	Bell Cut Off Time (minutes)
⑥	Part Set Error Tone Suspension Time (seconds)
⑨	Zone Soak Test Time (days)

To program any of the above, from the Programming Menu, press ③ followed by the corresponding time delay number (e.g. for the Part Set Entry Time, enter ③④). The display will look like this.



Enter the desired time as a two digit number (e.g. for 5 seconds enter ①⑤). The display will indicate as each digit is entered. Press (PROG). The system will chime to confirm the new time has been accepted. The system will automatically revert to the Programming Menu and all the zone lights will illuminate.

NOTE The Bell Cut Off Time ⑤ is the length of time for which the bell sounds. Some bell boxes have a built in timer. In this case the bell will sound for either its built in time or the programmed cut-off time, whichever is the shorter.

The Part Set Error Tone Suspension Time ⑥ would typically be used to suspend the error tone (indicating an open zone) to avoid disturbance when there are detectors on the part set exit route.

The Zone Soak Test Time ⑨ is used in conjunction with the Zone Soak Test Suite (see page 25).

The Seven Event Basic Log ④① - ④⑦

The control panel has a Seven Event Basic Log which stores the last 7 alarm activations. The zone that caused the initial alarm activation will flash, and any subsequently opened zones will also be shown (not flashing).

Clearing the Seven Event Basic Log ④①

From the Programming Menu, enter ④①. The display will look like this.



Press (PROG). The system will chime to confirm that the Seven Event Basic Log has been erased. The system will then automatically revert to the Programming Menu.

Displaying the Seven Event Basic Log ④① - ④⑦

From the Programming Menu, press ④ followed by the number corresponding to the desired event, ① being most recent, ⑦ being least recent (e.g. to recall the second most recent event, enter ④②). The zone that caused the initial alarm activation will flash, and any subsequently opened zones will also be shown (not flashing).



If the Tamper indicator is on or flashing, an extended display reveals more information about the source of the tamper alarm. To toggle between the normal display and the extended display, press (EXT). The extended display is distinguished from the normal display by the Unset light being off. In the extended display the zone indicators are interpreted as follows:

Zone Light	Description
1	Bell Tamper (including Aux Tamper)
2	Not Applicable
3	Lid Tamper (including RKP Lid Tamper)
4	Not Applicable
5	RKP Off-Line
6	Code PIN Tamper
7	Keypad PA
8	Not Applicable

Press (RESET). The system will return to the Programming Menu.

Programming the Suites ④⑧ - ⑤⑦

The system has two Part Set Suites, a Chime Suite, a Double Knock Suite, a Manual Omit Suite, a Zone Disable Suite and a Zone Soak Test Suite all of which are programmable.

24 Hour zones (Fire, PA and Tamper), Keyswitch zones and Push to Set zones should be monitored constantly and should NOT be omitted by the Part Set Suites.

Programming the Zone Disable Suite ④⑧

The Zone Disable Suite defines the zones that are not monitored. Disabled zones cannot cause an alarm.

A zone could be disabled if it was not being used i.e. whilst waiting for a faulty detector to be replaced.

From the Programming Menu, enter ④⑧. The zones currently included in the Zone Disable Suite will indicate (zones not included will remain off).



Press the appropriate numbered button(s) of the zone(s) to be included or excluded. Press (PROG). The system will chime to confirm that the new Zone Disable Suite has been accepted. The system will then automatically revert to the Programming Menu.

NOTE If a zone is disabled in this suite it will be necessary to enter the suite again to re-enable it.

Programming the Zone Soak Test Suite ④⑨

The Zone Soak Test Suite defines the zones that are on Soak Test.

Soak Test is used to prevent false alarms for a set period after a new installation or when a detector has been replaced. If a zone on Soak Test activates it will not cause alarm or activate the communicator interface but it will still be logged. Afterwards the zone will have a standing fault and will need to be omitted before the system can be set. After the Soak Test Time (see page 24) zones that have not activated will be automatically removed from the Soak Test Suite.

From the Programming Menu, enter ④⑨. The zones currently included in the Zone Soak Test Suite will indicate (zones not included will remain off).



Press the appropriate numbered button(s) of the zone(s) to be included or excluded. Press (PROG). The system will chime to confirm that the new Zone Soak Test Suite has been accepted. The system will then automatically revert to the Programming Menu.

NOTE Soak Test is not appropriate for Entry/Exit, Push to Set, or Keyswitch Zone Types and these zones will still be monitored as normal even if they are included in the Soak Test Suite.

Zones which fail Soak Test will be automatically added to the Manual Omit Suite (see page 26) which should be checked after a Soak Test failure.

When the Soak Test Suite is programmed the Soak Test Time is started therefore this should be programmed first (see page 24).

Zones that have failed Soak Test will be cleared when the Soak Test Suite is programmed.

If a Soak Test zone activates all subsequent zone activations will be logged as well. For example, zones 5, 6, 7 & 8 are on Soak Test. Zones 7 & 8 activate and are logged (zone indicator On). The user then returns via Zone 1, Zone 2 & Zone 3. These zones will all be logged as well but while Zone 2 & 3 indicators will be On, Zone 1 indicator will be Flashing as this was the first non Soak Test zone to be activated.

Programming the Part Set Suites ⑤① - ⑤②

A Part Set Suite defines the zones that will be automatically included and excluded (omitted) when the system is part set.

From the Programming Menu, **press ⑤ followed by the suite number ① or ②** (e.g. to program Part Set Suite 2, enter ⑤②). The zones currently active in the selected part set will indicate (the omitted zones will remain off).



Press the appropriate numbered button(s) of the zone(s) to be included or excluded (omitted). Press **(PROG.)**. The system will chime to confirm that the new Part Set Suite has been accepted. The system will then automatically revert to the Programming Menu.

Programming the Chime Suite ⑤⑤

The Chime Suite defines the zones that will be automatically included and excluded (omitted) when chime is turned on.

From the Programming Menu, **enter ⑤⑤**. The zones that will chime when chime is turned on will indicate (zones that won't chime will remain off).



Press the appropriate numbered button(s) of the zone(s) to be included or excluded. Press **(PROG.)**. The system will chime to confirm that the new Chime Suite has been accepted. The system will then automatically revert to the Programming Menu.

NOTE For a description of how to turn Chime on and off see the User Guide.

Programming the Double Knock Suite ⑤⑦

The Double Knock Suite defines the zones that will be assigned the double knock attribute

From the Programming Menu, **enter ⑤⑦**. The zones currently included in the Double Knock Suite will indicate (zones not included will remain off).



Press the appropriate numbered button(s) of the zone(s) to be included or excluded. Press **(PROG.)**. The system will chime to confirm the new Double Knock Suite has been accepted. The system will automatically revert to the Programming Menu.

NOTE A zone should be assigned a double knock attribute when maximum false alarm protection is required. A zone with a double knock attribute must be activated either twice within 10 seconds or once for longer than 10 seconds in order to cause an alarm.

Double knock is not recommended for Entry/Exit zones.

Double knock will not operate with Push to Set or Keyswitch zones.

Double knock should NOT be used for Fire, Panic, or Tamper zones.

Programming the Manual Omit Suite ⑤⑧

The Manual Omit Suite defines the zones that may be manually omitted by the user.

From the Programming Menu, **enter ⑤⑧**. The zones currently included in the Manual Omit Suite will indicate (zones not included will remain off).



Press the appropriate numbered button(s) of the zone(s) to be included or excluded. Press **(PROG.)**. The system will chime to confirm that the new Manual Omit Suite has been accepted. The system will then automatically revert to the Programming Menu.

NOTE To prevent the user from omitting 24 Hour zones (Fire, PA and Tamper) these would be excluded from the Manual Omit Suite.

Zones not included in the Manual Omit Suite will still be omitted if they are excluded in the Full or Part Set Suites.

Programming Codes ⑥①

Changing the Engineers Code ⑥①

Each user has a programmable 4 digit Personal Identification Number (PIN) which the user enters in order to operate the alarm system.

Every user has the ability to change their own 4 digit Access code, as follows:

From the Programming Menu, **enter ⑥①**. The display will look like this.



Enter the new Access code ②②②②. The display will indicate as each digit of the new code is entered. Press **(PROG.)**, the system will chime to confirm the new code has been accepted. The system will then automatically revert to the Programming Menu.

5. Specifications

Control Panel

Power supply

Mains Supply Voltage:	230VAC ($\pm 10\%$) 115VAC ($\pm 10\%$)
Maximum Total Current Rating 230VAC/115VAC ($\pm 5\%$)	1A _{DC}
Ripple	<5%
Rechargeable Battery Type	12V Sealed Lead Acid Gel

Electrical

Current Consumption

Quiescent	<50mA
In Alarm	<150mA

Fuses

FTB Mains 230V	125mA, 250V, 20mm
FTB Mains 115V	250mA, 250V, 20mm
F1 - Battery	1 Amp, 250V, 20mm
F2 - Bell	1 Amp, 250V, 20mm
F3 - Auxiliary	500mA, 250V, 20mm
F4 - Network	500mA, 250V, 20mm
F5 - Power Supply Output	1.6 Amp, 250V, 20mm

Rechargeable Battery Capacity

<i>Veritas 8Compact</i>	Up to one 12V 2.1Ah
<i>Veritas 8 and R8</i>	Up to one 12V 7.0Ah

Number Of Zones

8

Zones Types

N/C

Tamper Loop Threshold

Minimum Open Resistance	110k Ω
Maximum Closed Resistance	20k Ω

Network

+	+12V Power
-	0V Power
T	Transmitted Data
R	Received Data

Types Of Remote Keypads

LED Only

Number Of Remote Keypads

Up to six

Internal Speaker

Minimum Load	16 Ω
Low Volume	Adjustable
High Volume	>90dB at 1m

Physical

Dimensions	282mm x 225mm x 80mm
Battery Compartment	Up to one 12V 7Ah battery

Environmental

Operating Temperature	-10°C (+14°F) to +50°C (+122°F)
Storage Temperature	-20°C (-4°F) to +60°C (+140°F)
Maximum Humidity	95% non-condensing
EMC Environment	Residential, Commercial, Light Industrial & Industrial

Keypads

Electrical

Operating Voltage	10V - 13.7V _{DC}
Current Consumption	<85mA
Volume	Dual Level
Cable	4-Core, ≤ 100 m, Star, Daisy Chain or any combination

Safety Notes



Mains voltage is factory set and not adjustable - see label on transformer.

Removal of the transformer is prohibited and will invalidate the warranty.

Only use batteries of the specified type.

Dispose of used batteries safely according to the manufacturer's instructions.

Locate the battery inside the panel in the space provided.

This equipment is designed for dry indoor use only.

When replacing a fuse always observe the specified rating and type - failure to do so is dangerous and will invalidate the warranty. Fuses should comply with IEC 127.

The press-seal bag must NOT be stored inside the panel.

Warranty

All Texecom products are designed for reliable, trouble-free operation. Quality is carefully monitored by extensive computerised testing. As a result the Control Panel is covered by a two year warranty against defects in material or workmanship (details on request).

As the Control Panel is not a complete alarm system but only a part thereof, Texecom cannot accept responsibility or liability for any damages whatsoever based on a claim that the Control Panel failed to function correctly. Due to our policy of continuous improvement Texecom reserve the right to change specification without prior notice.

The *Veritas 8*, *Veritas 8Compact* and *Veritas R8* are protected by UK & International Registered Design. Registered Design Numbers: 2041829, 2055230 and 2041830.

Veritas is a trademark of Texecom Ltd.

European Standards

Conforms to European Union (EU) Low Voltage Directive (LVD) 73/23/EEC (amended by 93/68/EEC) and Electro-Magnetic Compatibility (EMC) Directive 89/336/EEC (amended by 92/31/EEC and 93/68/EEC).

The CE mark indicates that this product complies with the European requirements for safety, health, environmental and customer protection.

EN 50131

In order to comply with EN 50131-1 several functional changes may be invoked using Miscellaneous Selections Zero, Option 5 (see page 17). In addition the following points should be noted:

- In order to comply with EN 50131-1 Engineer access must first be authorised by a user, therefore Installer codes will only be accepted when the system is unset. If additional restriction is required then Engineer access may be time limited to the first 30 seconds after the system is unset (see page 17).
- In order to comply with EN 50131-1 neither Internals Only on Part Set Zone Alarm nor Internals Only on Part Set Tamper Alarm should be selected (see page 18).
- In order to comply with EN 50131-1 Single Button Setting should not be selected (see page 17).
- In order to comply with EN 50131-1:
 - Do not fit more than 10 unpowered detectors per zone,
 - Do not fit more than one non-latching powered detector per zone,
 - Do not mix unpowered detectors and non-latching powered detectors on a zone.
- In order to comply with EN 50131-1 the Entry Time should not be programmed to more than 45 seconds (see page 24).
- In order to comply with EN 50131-1 the Bell Cut-Off Time should be programmed between 02 and 15 minutes (see page 24).
- In order to comply with EN 50131-1 the Bell Delay Time should not be programmed to more than 10 minutes (see page 24).
- EN 50131-1 requires that detector activation LEDs shall only be enabled during Walk Test. This is most conveniently achieved by using detectors with a Remote LED Disable input (e.g. the Texcom *Rf360*, *Rf650* & *RfExtreme* PIRs) connected to the panel SW+ output, programmed to operate during Walk Test (see page 20).
- EN 50131-6 requires that the power supply output ripple should not exceed 5% at mains voltages down to 207V_{AC}. This limits the maximum rated output of the power supply to 600mA. The power supply can supply more than this at higher mains voltages or if greater ripple is accepted, for example at 230V_{AC} the power supply can deliver up to 1A.

- The standby time is the time for which the system power supply is capable of supplying its rated output current when running on battery only (i.e. in the event of mains failure). In order to comply with EN 50131-1 the standby time should be at least 8 hours for Grade 1 Systems and at least 15 hours for Grade 2 Systems. In order to comply with EN 50131-6 the Standby Time should be at least 12 hours for both Grade 1 and 2 Systems. For smaller battery sizes this means that the rated output of the power supply will actually be determined by the capacity of the standby battery and will be less than the power supply is capable of supplying (with the mains on). The rated output of the power supply may be calculated by dividing the capacity of the battery by the required standby time where the result is smaller than the maximum rated output of 600mA.

Rated output currents for typical battery sizes are shown in the following table:

		Standby Time		
		8hrs	12hrs	15hrs
Battery Capacity	1.2Ah	150mA	100mA	80mA
	2.1Ah	263mA	175mA	140mA
	3.0Ah	375mA	250mA	200mA
	7.0Ah	600mA	583mA	467mA

1. Engineer Reset prevents the user from resetting the system. It is not in itself a method of resetting the system.
2. EN 50131-1 separately defines Zone Inhibit and Zone Isolate optional facilities. The Zone Omit facility supported by the Control Panel corresponds to Inhibit. The Zone Disable facility supported by the Control Panel corresponds to Isolate.
3. When the battery voltage falls below the minimum system operating voltage it will be indicated as a power fault if the mains is on and will cause alarm if the mains is off.
4. The Control Panel Reset facility corresponds to the EN 50131-1 Restore function.
5. EN 50131-6 states that for integrated power supplies the environmental and tamper considerations of the control panel should be applied.

This equipment is designed to enable an intruder alarm system in which it is installed to comply with the requirements of security grades 1 or 2 of EN 50131-1, and EN 50131-6, and is suitable for installation in any indoor environment.

6. Installation Records

Installation Details

Installation Engineer: _____
Installation Company: _____
Address: _____

Telephone: _____
Installation Date: _____

Zone	Zone Type	Area Protected	Low Loop Resistance (Clear)	High Loop Resistance (Fault)
1				
2				
3				
4				
5				
6				
7				
8				

 The Instructions **MUST NOT** be stored inside the Control Panel.

Maintenance & Call-Out Record

Date/Time	Reason for Site Visit	Work Carried Out	Name of Engineer

 The User Guide contains **ESSENTIAL SAFETY INFORMATION** and **MUST** be given to the user.

Notes

7. Registered Installer Application Form



Partly Completed Forms CANNOT be accepted.

Please use Black Ink and Block Capitals.

Name: _____ Position: _____
 Company: _____ Fax: _____
 Tel: _____ E-Mail: _____
 Mobile: _____ Web Site: _____
 Address: _____

 _____ POSTCODE: _____

Which Distributors do you buy from? (Indicate at least one).

1	_____
2	_____
3	_____

How many Intruder Alarm Systems do you install on each month?

How many of the following Texecom products do you currently install each month?

Detectors:

Control panels:

External Sounder and Strobe Units:

Batteries:

Cameras:

Accessories:

Fax back to 01706 213187 or post to the address overleaf.

Alternatively register online at www.texecom.com



There's only ONE way to get

FREE

TECHNICAL SUPPORT...

REGISTER!

And receive the following exclusive benefits:

- **Access to the Secure Area of the Texecom Website**
 - **Freephone Technical Helpline***
 - **Free Product Voucher***
 - **Free Product Training***
 - **Latest Product Information**

Register online at www.texe.com or simply complete the form on the reverse of this page and return it to Texecom to become a Registered Texecom Installer.

***Available to UK Registered Installers only.**

Texecom
www.texe.com

Texecom Limited, Bradwood Court, St. Crispin Way, Haslingden, Lancashire BB4 4PW, England.

Technical Support:

Tel: +44 (0)1706 234833

Tel: +44 (0)1706 234811

Fax: +44 (0)1706 213187

© TEXECOM LTD. 2000 - 2005